



CERAFIELD

CERAFIELD BRAND BOOK



www.cerafield.com

Elevate Your Everyday Flow



About Us

With decades of exploration in the field of sanitaryware, we have ambitions to become the industry benchmark in China and even the world. Cerafield's origins can be traced back to the founding of Ceramate in 1983 in Taiwan as an agent of ceramic equipment and raw materials. In a constant search for change, we made our first transition in the early 1990s with the establishment of Futon, a factory specializing in the production of ceramic sanitaryware and tableware.

We have never stopped evolving, and in 2006 we established Cerafield, which not only marked a new venture in the sanitaryware sector, but also officially launched our involvement in supply chain management related to sanitaryware exports. These decades of successful export experience have given us the ambition to build and promote our brand worldwide.

Why Cerafield?

Cerafield is committed to providing the best bathroom solutions for every customer. The unique combination of European design and Chinese manufacturing guarantees exceptional quality at each stage, from design and development to the final shipment to consumers.



A 160 cubic meter fully automatic shuttle kiln

160m³

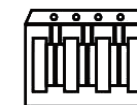

10 fully automatic high-pressure injection molding production lines

10 trip



square meters area

60.000m²



Fully automatic robot glazing Robot glaze spraying machine

5 crup + 5 Tomer

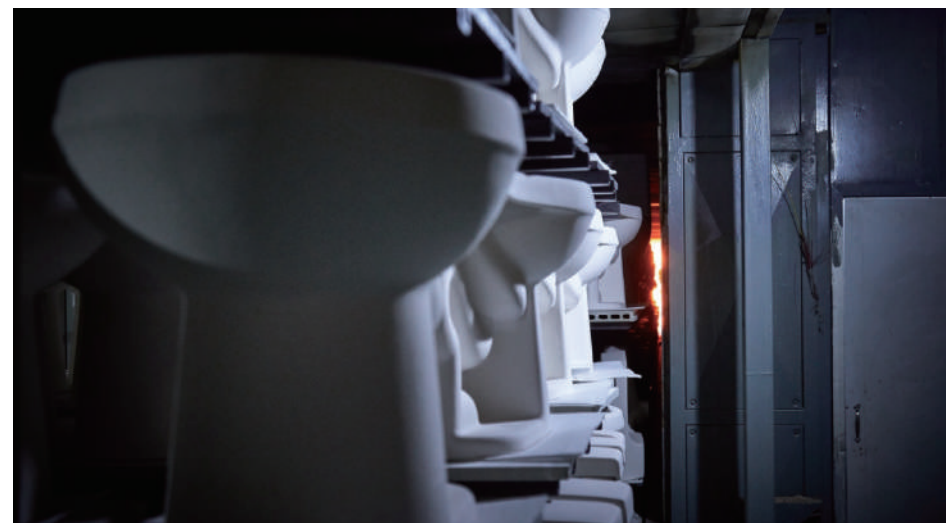
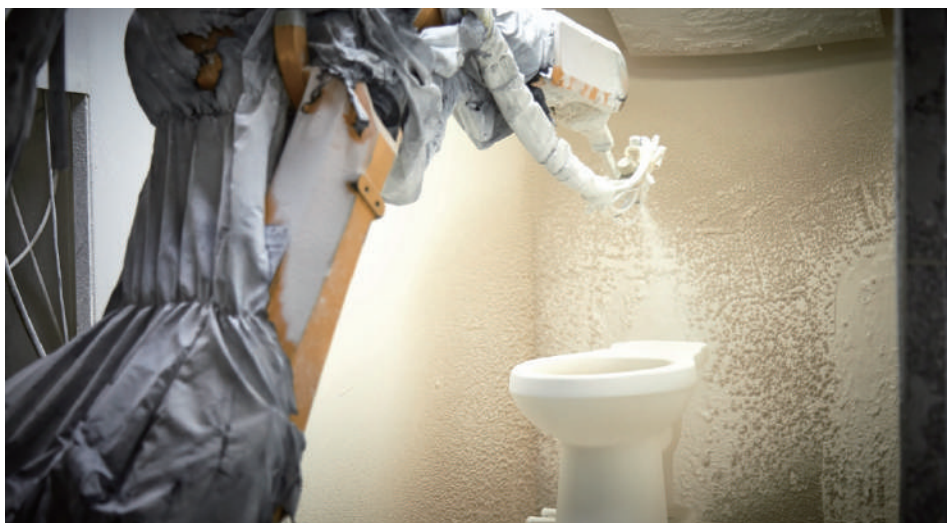

Sustainable Technology

The new vortex flushing technology converts the energy of the water tank into the best flushing effect, achieving 360° comprehensive cleaning.



360° VORTEX FLUSHING SYSTEM

Half moon shaped rinse board, with smoother and softer exterior lines, giving it a more aesthetic feel. A complete vortex flushing system is formed by combining 9 and a half month diversion holes and 1 vortex outlet, which conducts 360° scouring on the inner wall of the toilet, forming vortices to remove dirt, quickly generating siphons to enhance impulse, and making it more silent and water-saving.



RIMLESS

The design of the new frameless system solves the traditional problem of blind spots on the edge of rinsing, making it no longer difficult to reach or clean, reducing bacterial growth, and strengthening the protection of household hygiene and health issues.



Elevate Your Everyday Flow

"Elevate Your Everyday Flow" is more than just a slogan; it's an invitation to transform ordinary moments into extraordinary experiences with the "CERAFIELD" products. Each component in every "CERAFIELD" series exemplifies the devotion to design quality. The smooth lines and careful details are intended not only to satisfy the eye, but also to improve the operation of each part.

It's about elevating the ordinary to the extraordinary, making even the simplest act become a moment of refined indulgence. The use of the word "flow" in the name takes on a new dimension with this slogan. It's an encouragement to go beyond the routine, to embrace the beauty and grace embedded in the collection. "Elevate Your Everyday Flow" promises a seamless integration of style and utility, promising users an experience that transcends the ordinary.



C-heritage

A Timeless Ode to Craftsmanship

C-HERITAGE by CERAFIELD - the epitome of timeless elegance and masterful craftsmanship. This collection, proudly serving as a main line, draws inspiration from the rich history and artisanal legacy rooted in Futon China. Each piece is meticulously designed to reflect the essence of Siheyuan architecture, capturing the

strength and reliability of square shapes that echo through generations of craftsmanship. C-HERITAGE isn't just a bathroom collection; it's a living testament to the enduring beauty of classic design, seamlessly fitting into any space and function. Elevate your space with the C-HERITAGE Collection a celebration of classic design that stands as a tribute to the heritage, craftsmanship, and timeless sophistication at the heart of CERAFIELD.

CF-18037

Wall Hung Bidet
Size: 520x445x360mm

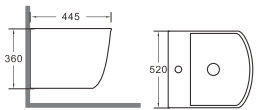

CF-BD14

Floor Standing Bidet
Size: 500x360x410mm

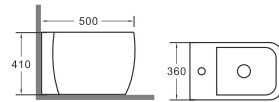

CF-BD13

Wall Hung Bidet
Size: 500x360x310mm

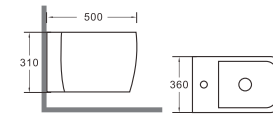

CF-12014

Two-piece Toilet
Flushing System: Tornado
Size: 635x360x850mm
P-trap: 180mm roughing in
S-trap: 250mm roughing in

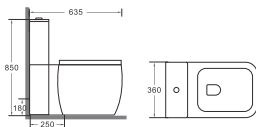

CF-FT07

Floor Standing Toilet
Flushing System: Tornado
Size: 500x360x410mm
P-trap: 180mm roughing in

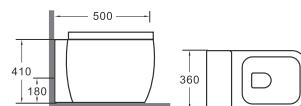

CF-15001

Wall Hung Toilet
Flushing System: Tornado
Size: 500x360x310mm
P-trap: 180mm roughing in

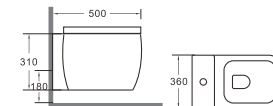

Lagoons

Where Nature Meets Elegance in Your Bathroom

The collection drew inspiration from the enchanting surroundings, where nature seamlessly blended vibrant greenery with the warm embrace of crystal-clear waters. The creators sought to capture the essence of the island's tranquility by incorporating the gentle curves and soothing lines of the oval shape, representing a harmonious union of nature and minimalistic design.

Beyond functionality, the LAGOONS Collection is a statement of refined taste. Elevate your bathroom aesthetics and showcase your appreciation for elegance with a collection that speaks volumes without saying a word. Indulge in the beauty of the LAGOONS Collection - where nature meets sophistication, and let the enchantment of Halkidiki become an integral part of your daily routine.

CF-BD015

Wall Hung Bidet

Size: 520x360x300mm

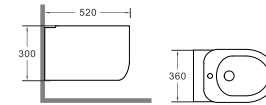

CF-15027

Wall Hung Toilet

Flushing System: Tornado

Size: 520x360x355mm

P-trap: 180mm roughing in

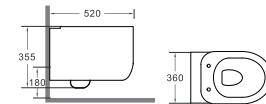

CF-12016

Two-Piece Toilet

Flushing System: Tornado

Size: 630x360x845mm

S-trap: 250mm roughing in

P-trap: 180mm roughing in

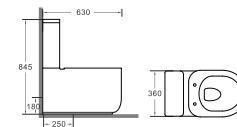

Fluir

The Harmony in Flow As the name implies

Experience the art of seamless living with 'FLUIR,' where the name derived from the Spanish term for 'flow,' captures the essence of our artist's vision. Crafted as a natural extension of the VIPER and C-HERITAGE Collections, 'FLUIR' promises not just a toilet

but a perfect integration of aesthetics and functionality. Inspired by the graceful architecture of the Siheyuan and mirroring the aerodynamic lines of cockpit, 'FLUIR' speaks a visual language of movement and stability. The curves and connections within the collection emphasize a perfect balance, creating focal points that embody harmony in every detail.

CF-15028

Wall Hung Toilet

Flushing System: Tornado

Size: 520x375x390mm

P-trap: 180mm roughing in

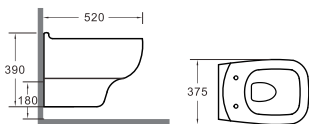

CF-BD016

Wall Hung Bidet

Size: 520x375x390mm

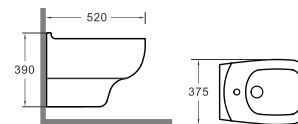

Lithe

Embracing Modern Femininity

The LITHE Collection, a testament to modern femininity, was born from the very essence of its name. Inspired by the word 'LITHE,' this series is a celebration of empowering women with a design that speaks to contemporary elegance and comfort. The concept is not just about bathroom fixtures; it's about creating an environment that resonates with the modern, empowered woman. Designed for universal appeal, the LITHE Collection transcends gender boundaries, offering a refined touch to modern interiors.



Viper

BY BERNAT LIONCH

The VIPER Series - A Skyward Symphony of Innovation - a pinnacle of bathroom luxury that seamlessly marries cutting-edge technology with visionary design. Born from an international collaboration between CERAFIELD and acclaimed Spanish designer Bernat Llonch, this collection draws inspiration from the aerodynamic marvels of the F-16 cockpit, showcasing the sleek tear drop shape.

CF-15030

Wall Hung Toilet

Size: 425x540x360mm

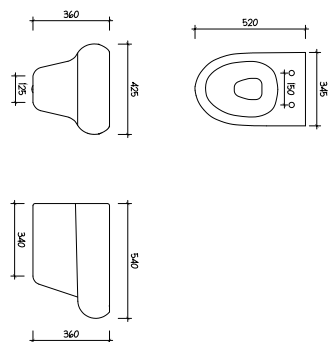

CF-BD018

Wall Hung Bidet

Size: 425x540x360mm

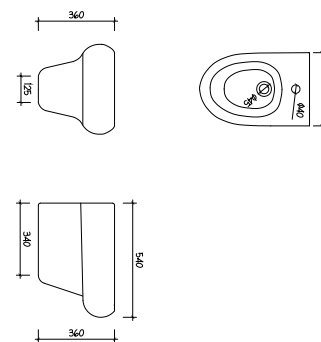

C-cube

Embracing Urban Rhythm with Timeless Design

Elevate your urban oasis with the C-CUBE Toilet Collection –where the metropolis of Shanghai meets the tranquility of modern design. Immerse yourself in the sleek C curves and geometric precision inspired by the city's skyline, creating a bathroom sanctuary that embodies both speed and harmony. More than fixtures, C-CUBE connects you to the pulse of urban living, offering a piece of peace in the heart of the concrete jungle. Bring the essence of Shanghai into your home and experience the seamless blend of style and tranquility with C-CUBE.

CF-15029

Wall Hung Toilet

Flushing System: Tornado

Size: 520x360x345mm

P-trap: 180mm roughing in

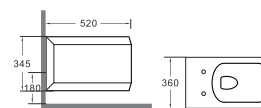

CF-BD017

Wall Hung Bidet

Size: 520x360x345mm

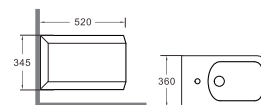

CF-12017

Two-piece Toilet

Flushing System: Tornado

Size: 630x360x845mm

S-trap: 250mm roughing-in

P-trap: 180mm roughing-in

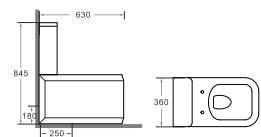

SOL

Embracing Warmth, Care, and Safety

In crafting the Sol Series, CERAFIELD's artist draw inspiration from the very essence of its name - 'SOL,' meaning sun in Spanish. This collection is more than just a series of elderly toilet products;

it encapsulates the concept of warmth and caring within the family. Specifically designed for our elderly users, SOL is a testament to meticulous attention to functional details and materials, prioritizing their comfort, safety, and well-being. The design inspiration for SOL stems from the concept of a spaceship seat - a symbol of support and essential functionality.

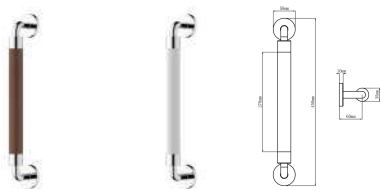

Product: Handrail

Item No.: CF-101-1(Wood) CF-101-2(White)

Materials: Zinc Alloy+Sapele (Wood)or Beech (White Paint)+Galvanized Mounting Plate+ABS

Weight/pc: 0.8kg

Dimension of Product: 400*80*60mm

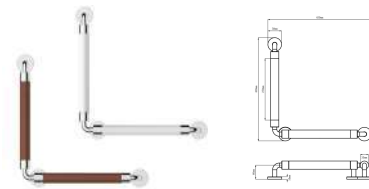

Product: L Handrail

Item No.: CF-102-1(Wood) CF-102-2 (White)

Materials: Zinc Alloy+Sapele (Wood)or Beech (White Paint)+Galvanized Mounting Plate+ABS

Weight/pc: 1.5kg

Dimension of Product: 450*400*80mm



Product: 135° Handrail

Item No.: CF-103-1(Wood) CF-103-2(White)

Materials: Zinc Alloy+Sapele (Wood)or Beech (White Paint)+Galvanized Mounting Plate+ABS

Weight/pc: 1.5kg

Dimension of Product: 630*330*80mm



Product: Toilet Aids Handrail

Item No.: CF-107

Materials: Al Alloy+Soft Plastic+ABS

Weight/pc: 3.45kg

Dimension of Product: L: 625mm

SOL





Product: Showering Seat
Item No.: CF-001
Materials: ABS+Stainless Steel+Al Alloy
Weight/pc: 4.25kg
Dimension of Product:
 40*390*45 (unfolded) 40*80*514 (closed)mm



Product: Showering Seat
Item No.: CF-002
Materials: ABS+304 Stainless Steel
Weight/pc: 4.22kg
Dimension of Product:
 360*03*210 (unfolded) 360*25*30 (closed)mm



Product: Showering Seat
Item No.: CF-003
Materials: ABS+Galvanized Shet
Weight/pc: 4.7kg
Dimension of Product:
 364*320*310 (unfolded) 364*70*310 (closed)mm



Product: Showering Seat
Item No.: CF-005
Materials: PP+Nylon
Weight/pc: 2.25kg
Dimension of Product:
 381*287*291 (unfolded) 381*74*291 (closed)mm



Product: Showering Seat
Item No.: CF-006-1 (white) CF-006-2 (black)
Materials: FU Urea Formaldehyde+
 Nylon+Silica Gel
Weight/pc: 2.5kg
Dimension of Product:
 350*40*15 (unfolded) 350*50*392 (closed)mm



Product: Showering Seat
Item No.: CF-007
Materials: SU304 Stainless Steel+
 Red Oak+POM
Weight/pc: 3.9kg
Dimension of Product:
 40*340*268 (unfolded) 40*84*340 (closed)mm



Product: Showering Seat
Item No.: CF-105
Materials: SU304 stainless steel+
 AL 6063+HDPE+TPR
Weight/pc: 5.7kg
Dimension of Product:
 580*450*860-940(adjustable)mm



Product: Handrail

Item No.: CF-104-1

Materials: Nylon+Stainless Steel+ABS
color options: white or yellow

Weight/pc: 1.02kg

Dimension of Product: L: 600mm

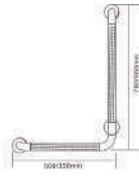

Product: L Handrail

Item No.: CF-104-2

Materials: Nylon+Stainless Steel+ABS
color options: white or yellow

Weight/pc: 1.94kg

Dimension of Product: 500*700mm

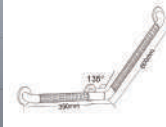
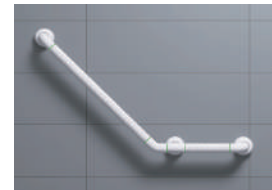

Product: 135° Handrail

Item No.: CF-104-3

Materials: Nylon+Stainless Steel+ABS
color options: white or yellow

Weight/pc: 1.69kg

Dimension of Product: 600*350mm

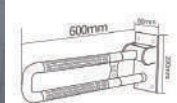

Product: U Foldable Handrail

Item No.: CF-104-4

Materials: Nylon+Stainless Steel+ABS
color options: white or yellow

Weight/pc: 2.33kg

Dimension of Product: L: 600mm

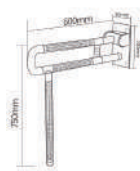

Product: Floor Mounted U Handrail

Item No.: CF-104-5

Materials: Nylon+Stainless Steel+ABS
color options: white or yellow

Weight/pc: 2.88kg

Dimension of Product: 600*750mm

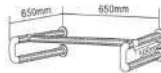

Product: Handrail For Lavatory

Item No.: CF-104-6

Materials: Nylon+Stainless Steel+ABS
color options: white or yellow

Weight/pc: 4.44kg

Dimension of Product: 650*650mm



Product: Floor Mounted Handrail For Lavatory

Item No.: CF-104-7

Materials: Nylon+Stainless Steel+ABS
color options: white or yellow

Weight/pc: 6.31kg

Dimension of Product: 650*650*850mm

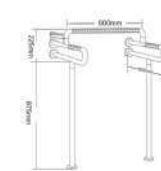

Product: Floor Mounted Handrail For Urinal

Item No.: CF-104-8

Materials: Nylon+Stainless Steel+ABS
color options: white or yellow

Weight/pc: 6.8kg

Dimension of Product: 600*225*1100mm



[www.cerafield .com](http://www.cerafield.com)

Flat/rm 1204 Yu Sung Boon
Bldg 107-111 Des Voeux Road Central HK